

ARB BASE RACK

FITTING INSTRUCTION

Part Number: 17900010, 30, 50 – 6 Leg

17900020, 40, 60, 70 – 4 Leg

Product Description: Roof Rack Fitting Kit 6 & 4 Leg

WARNING

NOTE THE FOLLOWING:

- ◆ Vehicle accessories which are not properly fitted can be dangerous.
- ◆ Please read these instructions carefully prior to fitting, and comply with the instructions at all times
- ◆ If in any doubt please contact your nearest ARB state office or the stockist from whom it was purchased.
- ◆ Do not use this product for any vehicle make or model, other than those specified by ARB.
- ◆ This product or its fixing must not be modified in any way.
- ◆ The installation of this product may require the use of specialized tools and/or techniques
- ◆ It is recommended that this product is only installed by trained personnel
- ◆ These instructions are correct as at the publication date. ARB Corporation Ltd. cannot be held responsible for the impact of any changes subsequently made by the vehicle manufacturer
- ◆ During installation, it is the duty of the installer to check correct operation/clearances of all components
- ◆ Work safely at all times
- ◆ Unless otherwise instructed, tighten fasteners to specified torque. Check torque after 500km and service intervals

ARB 4X4 ACCESSORIES

Corporate Head Office

42-44 Garden St
Kilsyth, Victoria
AUSTRALIA 3137

Tel: +61 (3) 9761 6622
Fax: +61 (3) 9761 6807

Australian enquiries
North & South American enquiries
Other international enquiries

sales@arb.com.au
sales@arbusa.com
exports@arb.com.au

www.arb.com.au

SAFETY

NOTE THE FOLLOWING:

Your ARB BASE RACK has a maximum carrying capacity of 150kg for the 6 leg model and 100kg for the 4 leg model. This load should not be exceeded and all loads must be tied down securely.

It is important to follow the listed usage instructions:

- ◆ The vehicle owner's manual should be consulted prior to loading the roof rack as the manufacturer's recommended maximum load for the vehicle's roof may be less than the maximum load specified for the roof rack and must not be exceeded.
- ◆ Calculation for permissible cargo:

$$6 \text{ leg kit: } \frac{\text{Vehicle max or 150kg}}{(\text{whichever is less})} - \frac{10kg}{(\text{kit weight})} - \frac{\text{rack weight}}{(\text{refer to box})} = \text{Net Payload}$$

$$4 \text{ leg kit: } \frac{\text{Vehicle max or 100kg}}{(\text{whichever is less})} - \frac{6.5kg}{(\text{kit weight})} - \frac{\text{rack weight}}{(\text{refer to box})} = \text{Net Payload}$$

- ◆ The maximum load per Base Rack cross beam is 25kg.
- ◆ Load must be evenly distributed and adequately secured.
- ◆ Any weight carried on the roof of the vehicle will adversely affect its handling, particularly in cornering or in a cross-wind, the vehicle should therefore be driven with increased discretion.
- ◆ Regularly check the tightness of the securing clamps and the security of the load.
- ◆ Attention is directed to statutory requirements regarding maximum permissible projections from vehicles.

All bolts should be checked prior to touring to ensure the rack is fastened correctly

FITTING REQUIREMENTS

REQUIRED TOOLS FOR FITMENT OF PRODUCT:

10mm spanner x 2	13mm spanner x 1
Tape (any type)	Hex Key (supplied in kit)
Measuring tape	

NOTE: 'WARNING' notes in the fitting procedure relate to OHS situations, where to avoid a potentially hazardous situation it is suggested that protective safety gear be worn or a safe work procedure be employed. If these notes and warnings are not heeded, injury may result.

FASTENER TORQUE SETTINGS:





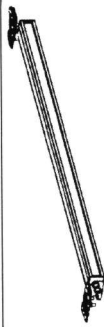

SIZE	Torque Nm	Torque lbf
M6	9Nm	7lbf
M8	22Nm	16lbf
M10	44Nm	32lbf
M12	77Nm	57lbf













Air Deflector and Base Rack Light Bar

An air deflector or Base Rack Light Bar should be fitted beneath the front edge of the Base Rack. Refer to the table below for the correct part number. If fitting the light bar in front of the Base Rack, an Air Deflector should also be fitted. Refer to the instructions provided with these products for further details.

	BASE RACK WIDTH		PART NUMBER
	1155	1285	
AIR DEFLECTOR			17900080
BASE RACK LIGHT BAR			17800090
		ALL	1780500

PARTS LISTING

DESCRIPTION	PART NO.	QTY 6 LEG	QTY 4 LEG	DIAGRAM
Leg		6	4	
Plate Washer RT	3193918	6	4	
Stud Plate	3195184	6	4	
Support Plate	3193917	6	4	
Foot	6317649	6	4	
Clamp	6582506 OR 6582508	6	4	
Rubber Clamp Cover	4601019	6	4	

Gutter Runner Plastic	4601281	6	4	
Gutter Runner Steel	5641108	6	4	
M6 Hex Key	6151264	1	1	
M8 x 30mm Socket head bolt	6151184	6	4	
M8 x 16mm Hex head bolt	6151020	12	8	
M8 flat washer stainless steel	4581081	18	12	
M6 x 16mm Hex head bolt	6151017	6	4	
M6 Flat washer	6151046	6	4	
M6 Flange nut	6151128	6	4	
M8 Nyloc nut	6151212	12	8	
M8 Stud	6151916	12	8	
Trim Clip	6151267	6	4	
Compliance Label	2125805 OR 2125806	1	1	

FITTING PROCEDURE

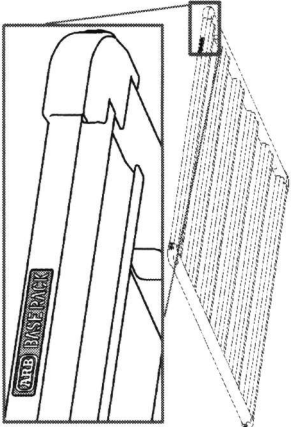
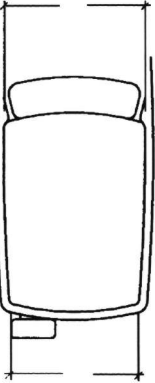
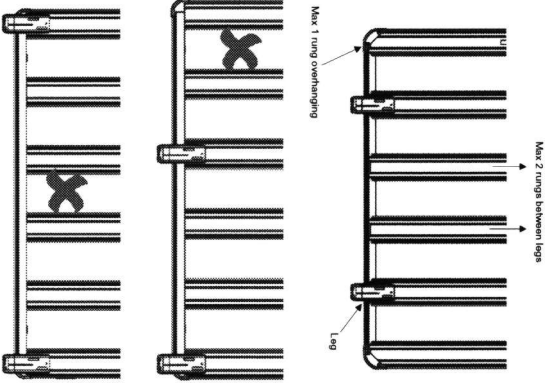
	<p>1. Place the BASE RACK on a stand, base up. The logo should be upside down</p>
	<p>2. Measure approximate widths of the roof gutters front and rear, and record</p>
	<p>3. The length of the rack and number of legs will determine leg position. There should be:</p> <ul style="list-style-type: none"> • No more than 1 rung over hanging from each end. • No more than 2 rungs between supports. • Preference towards the rear of the vehicle if uneven mounting positions must be used. • Preference towards mounting above pillars where possible

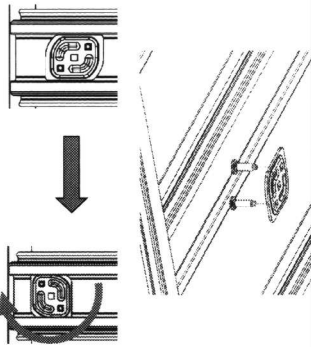
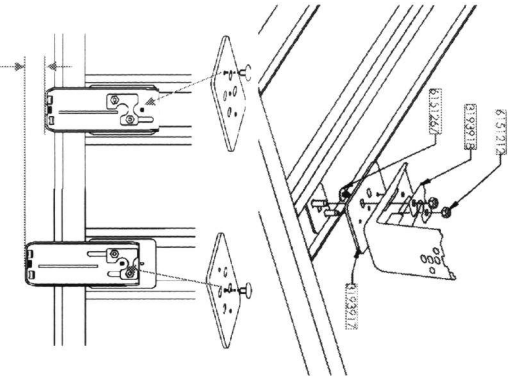
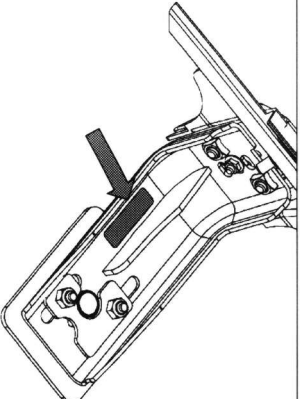
	<p>4. Insert the M8 studs into the stud plate</p> <p>5. Drop the stud plate into the extrusion, rotate 90° to lock</p>
	<p>6. The support plate can be fitted in two positions depending on the width of the vehicle</p> <p>7. Align the leg with one of the small holes in the Support Plate and locate using the supplied x-mas tree plug</p> <p>8. Slide the plate and leg over the studs in the BASE RACK and loosely fasten with the washer plate and M8 nuts</p>
	<p>9. Place the compliance label on the rear driver's side leg in the location shown. Rub firmly to ensure adhesion.</p>

FITTING PROCEDURE

10. Fasten a foot to each leg (in its highest position) by passing M8 x 16mm hex head bolts and M8 washers through the foot slots into the captive nuts in the leg. Do not fully tighten, allowing movement

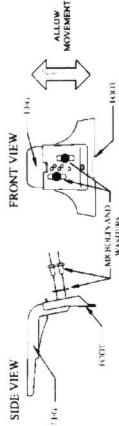

11. Set the width of the feet as measured on the vehicle previously

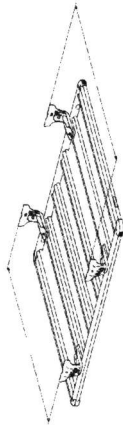

12. At this point the air deflector or light bar should be fitted. Refer to the instructions supplied with the product.

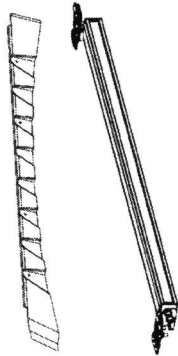

13. The gutter runners provided then fit directly onto each foot. It is recommended to temporarily tape the gutter runners to each foot as shown

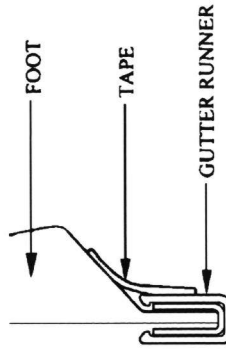

14. Once these procedures have been followed the rack can be lifted into position on your vehicle. It is advisable to use 4 people. The rack should be positioned with the gutter runner in the vehicle gutter. ARB recommends position the rack towards the rear of the vehicle as shown

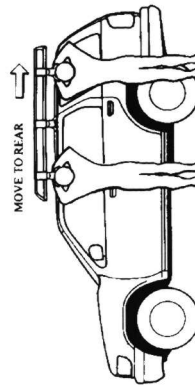

FITTING PROCEDURE

15. At this stage it is best to step back and view whether the rack is centred. As the width adjustment is not fully tightened the rack should be moved until it is centred over the vehicle. Refer to diagram shown

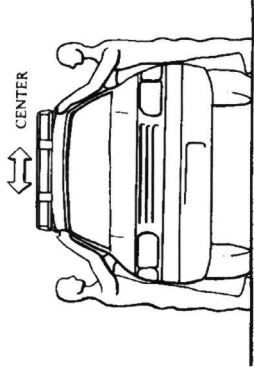

16. The feet should then be angled to sit flat in the vehicle gutter
17. Lock the leg and foot together by fastening the M6x16 bolt, washer and flange nut through one of the available holes as shown
18. Tighten M6 and M8 fasteners
19. The nuts connecting the legs to the BASE RACK can now be fully tightened to fix the width.

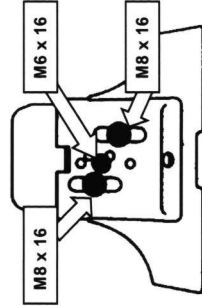

-  Torque M6 to 9Nm
-  Torque M8 to 22Nm

20. To complete fitment place the rubber clamp covers onto the clamps. Fasten the rack to the vehicle gutters using the rubber covered clamps and M8 x 30mm socket head bolts and washers. The bolts pass through the slots in the clamps into the captive nuts in the feet. This pulls the clamps both up and into the vehicle gutter. Excessive over tightening of these bolts may result in damage to the vehicle gutter.

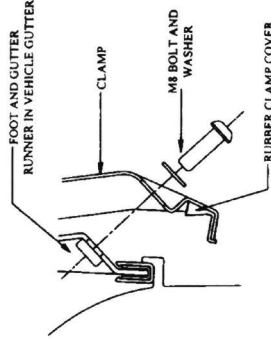

-  Torque M8 to 15Nm